

## UNIVERSAL GRINDING MACHINE

for the efficient, precise and complete processing of small and medium-sized components with the workpiece being clamped once only.



# The little machine with a maximum of flexibility.

Universal grinding machines of the WOTAN® S3U series are designed for processing small and medium-sized workpieces. The workpiece spindle can absorb loads of up to 400 kg. Our flexible machine design enables us to optimize each machine for your specific grinding jobs.

The WOTAN® S3U in its configuration as WOTAN® S3U-F is suitable for the internal, external and surface processing of chuck parts with a swing diameter of up to 400mm and a length of approx. 400mm that are clamped on one side ("flying") without any additional support.

Alternatively, it is also possible to grind shaft-type workpieces between centers externally without additional support. Here, the workpiece can have a maximum length of up to approx. 1.000mm.

The WOTAN® S3U is therefore ideal for grinding internal diameters and internal front surfaces as well as external diameters and external front faces. Chuck parts can thus be processed effectively on 4 sides with the workpiece being clamped once only.

The internal grinding unit is used for the internal processing, while the separately working external and surface grinding unit is employed for the external processing.

As an alternative, the machine can be configured with an extended work area as WOTAN® S3U-L. This version makes it possible to process shaft-type components with a length of up to 750 mm, apart from chuck parts clamped on one side only, for which, due to their geometry, a steady rest needs to be added. The diameter of the steady rest must not exceed 250mm.

This will ensure an effective 4-side processing with the workpiece being clamped once only which includes grinding internal diameters, internal front surfaces, external diameters and external front faces. However, external processing in this position will only be possible in front of the steady rest.

It goes without saying that shaft-type components (self-supporting, without any additional support) can be ideally ground externally between centers with such a machine design. The component length that can be clamped may, thanks to the longitudinal adjustment of the workpiece spindle headstock in Z-direction (L-adjustment), be extended to a maximum of 1 700mm.

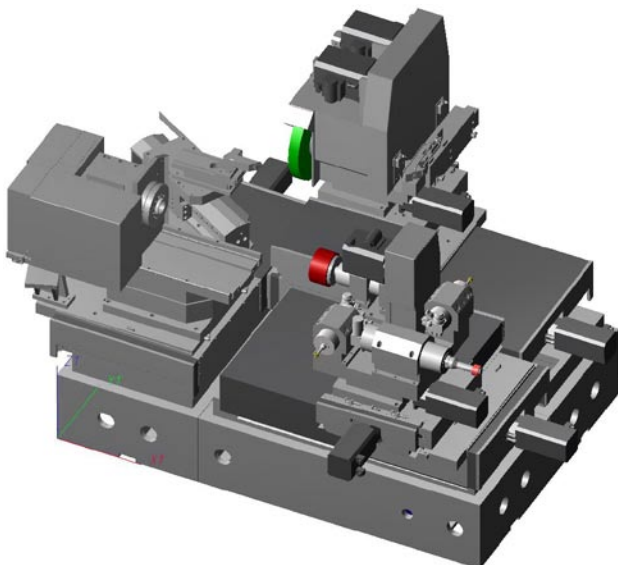

Example of the configuration of a WOTAN® S3U-L with L-adjustment

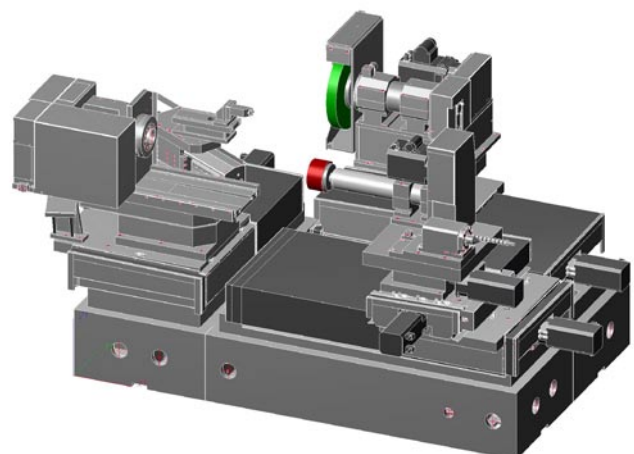

Example of the configuration of a WOTAN® S3U-L with tailstock

## WORKPIECE SPINDLE

On the machining side, both machine versions are equipped with a manual angle adjustment device (with angle measuring system) for correcting the cylindricity. Alternatively, the machine can also be equipped with a **continuously swiveling round table** (B1 axis) to swivel the workpiece spindle. This will allow the optimal grinding of **internal and external tapers** of chuck parts.

Furthermore, the entire workpiece spindle headstock will be positioned on a transverse axis (U axis), so that the machine's work area can be extended by positioning the entire workpiece spindle headstock crosswise. Since the U axis is a positioning axis, it will remain stationary during the grinding process.

## LARGE SELECTION OF SPINDLES

Depending on the accuracy requirements, the workpiece spindle can be designed as belt-driven or directly driven spindle or as spindle with a hydrostatic bearing. If the **workpiece spindle** (C axis), you can perform high-precision **non-round grinding operations** in various applications on a cylindrical grinding machine.

The internal grinding unit of the machine is mounted on a cross table that consists of a Z1 axis and an X1 axis. The X1 axis is rectangular positioned on the Z1 axis. Here, stepped internal diameters and internal front surfaces can be processed economically and efficiently in **one clamping**.

## OPTIONAL INTERNAL GRINDING SPINDLE TURRET

An optional **internal grinding spindle turret** (B2 axis) with **up to 4 internal grinding spindles** can increase the flexibility considerably without exchanging the spindles. It is either belt-driven internal grinding spindles or high-frequency **internal grinding spindles** that are used for this purpose. Belt-driven spindles can be manually exchanged which increases the variability even more.

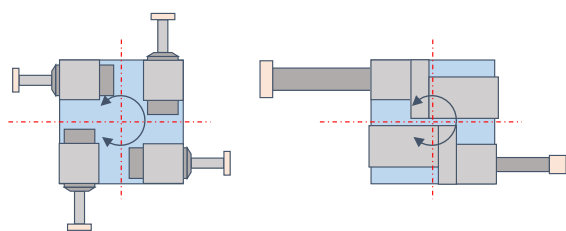

4 high-frequency spindles

2 belt-driven spindles



1 belt-driven spindle +  
2 high-frequency spindles

3 high-frequency spindles +  
1 tailstock

## EXTERNAL AND SURFACE GRINDING

Apart from the internal processing, the **external grinding between centers** is, of course, also possible. In order to do so, an **additional tailstock** will be put up on the internal grinding spindle revolver (B2 axis). This configuration makes it also possible to install up to 3 internal grinding spindles for a wide range of internal grinding jobs.

The **separately working external and surface grinding unit** is – like the internal grinding unit – put up on a cross table consisting of a Z2 axis and an X2 axis. The X2 axis will again be positioned on the Z2 axis is also rectangular. In this way, **stepped external diameters and external front faces** can be processed economically and efficiently in one clamping.

The machine will be equipped in its basic configuration with a stationary external and surface grinding unit. The grinding unit can be positioned at angles of 30°/45°/90° in relation to the workpiece axis. If, as an example, the grinding unit is positioned at an angle of 30° or 45° in relation to the workpiece axis, an external and surface grinding wheel profiled on both sides can be used. This will allow the clean processing of external front faces by way of **peripheral grinding** and the processing of external diameters by **applying inclined plunge cut grinding or longitudinal grinding techniques**.

If the external and surface grinding unit is positioned at an angle of, say, 90° in relation to the workpiece axis, a straight (cylindrical) external grinding wheel can be used, so that **external diameters** can be optimally processed by way of longitudinal grinding. It is, of course, also possible to grind **external front faces** by positioning the external grinding wheel on the face.

## EXAMPLE OF THE CONFIGURATION FOR THE B2 AXIS



An example of an external and surface grinding unit at an angle of 45° in relation to the work-piece axis with external and surface grinding wheel profiled on both sides

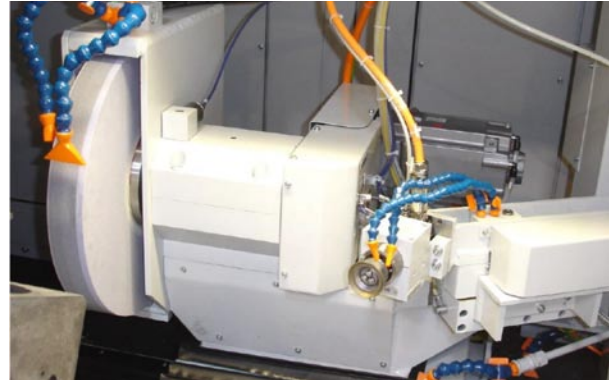

An example of an external and surface grinding unit at an angle of 90° in relation to the work-piece axis with a straight (cylindrical) external grinding wheel

#### OPTIONAL EXTERNAL GRINDING SPINDLE TURRET

The flexibility and diversity can be further increased – even without exchanging the spindles – by adding an external grinding spindle turret (B3 axis) with up to 2 external grinding spindles to the external grinding unit. This will allow, as an example, the optimal grinding of [external tapers](#) on components between centers.

When using [2 external grinding spindles](#), both a straight external grinding wheel and an external grinding wheel profiled on both sides can be used. Each of the two external grinding spindles is equipped with an [automatic balancing system](#).

#### VARIOUS DRESSERS CAN BE SELECTED

The machine is equipped with both an [internal dressing unit](#) and an [external dressing unit](#). Both dressing units can be equipped with [stationary and driven dressing tools](#), so that it is possible to work not only with conventional corundum grinding wheels but also with CBN grinding wheels.



An example of an external and surface grinding unit with a straight (cylindrical) external grinding wheel as well as an external and surface grinding wheel profiled on both sides (alternating use via the round table - B3 axis)

#### MODERN CONTROL AND EASY USER INTERFACE

The drive package is based on a [SINUMERIK 840 D](#) control – SOLUTION LINE – from SIEMENS with the latest generation of servo motors.

All machines are equipped with our own, user-friendly [operator interface with workshop oriented programming \(WoP\)](#) that allows an uncomplicated, menu-guided [operation of the machine and its programming without CNC knowledge](#). All operations necessary for the process allow the continuous handling of the machine, regardless of its operating status. The standard interface of SIEMENS is also available at the same time.

#### NUMEROUS OPTIONS AVAILABLE

Depending on the grinding job to be performed, we also integrate a spark-in control & incision detection via a fluid sensor system, more measuring equipment, re-tooling systems and much more.



An example of a tool changer that is integrated into the machine which also allows the machining of workpieces and measurements

# WOTAN® S3U at a glance:

	<b>WOTAN® S3U-F</b> (without longitudinal adjustment)	<b>WOTAN® S3U-L</b> (with longitudinal adjustment of the workpiece spindle headstock)
<b>Work area of the machine</b>		
swing diameter/workpiece diameter		
› for components clamped on one side only (chuck parts)	mm (max.) 400	400
› for shaft-type components between centers	mm (max.) 400	400
workpiece diameter in the steady rest	mm (max.) –	250
workpiece length that can be clamped		
› for components clamped on one side only (chuck parts)	mm (ca.) 400	400
› for shaft-type components between centers	mm (max.) 1.000	1.700
› for shaft-type components with steady rest	mm (max.) –	750
grinding diameter for internal grinding	mm (max.) 350	350
grinding depth for internal grinding	mm (ca.) 400	500
grinding diameter for external/surface grinding	mm (max.) 400	400
grinding length for external/surface grinding	mm (max.) 700	700
load-bearing capacity at spindle head (200 mm from the spindle nose)		
› for components clamped on one side only (chuck parts)	kg (max.) 400	400
› for shaft-type components between centers	kg (max.) 400	400
› for shaft-type components with steady rest	kg (max.) –	400
<b>Workpiece side/workpiece spindle headstock</b>		
› belt-driven	standard	standard
› directly driven	option	option
› with hydrostatic bearing	option	option
manual angle adjustment (with angle measuring system)	standard	standard
› swiveling range	from/to ° +8 / -1	+8 / -1
automatic angle adjustment via B1 axis (CNC)	option	option
› swiveling range	from/to ° +30 / -20	+20 / -10
C axis for out of round grinding	option	option
U axis (CNC) for positioning the workpiece spindle headstock crosswise		
› travel	mm (max.) 500	500
› calculation accuracy control	mm 0,0001	0,0001
› minimum adjusting increment	mm 0,001	0,001
› maximum speed	m/min 15	15
adjustment of the workpiece spindle headstock in Z-direction	mm (max.) –	1.000
option to use steady rests	no	yes
option of external grinding between centers	yes	yes
coolant flow in through the die workpiece spindle	option	option
incision detection/spark-in control via the fluid sensor system when grinding	option	option

**WOTAN® S3U-F**

(without longitudinal adjustment)

**WOTAN® S3U-L**

(with longitudinal adjustment of the workpiece spindle headstock)

**Internal grinding unit**

Z1 axis (CNC)			
› travel	mm (max.)	1.000	1.000
› resolution	mm	0,0001	0,0001
› minimum adjusting increment	mm	0,001	0,001
› maximum speed	m/min	15	15
X1 axis (CNC)			
› travel	mm (max.)	150/300	150/300
› resolution	mm	0,0001	0,0001
› minimum adjusting increment (on the radius)	mm	0,0005	0,0005
› maximum speed	m/min	15	15
stationary grinding spindles (without grinding spindle turret)		1	1
grinding spindle turret (B2 axis)		option	option
› grinding spindles on the grinding spindle turret	max. Pcs.	4	4
› grinding spindles on the turret with tailstock	max. Pcs.	3	3
continuously adjustable setting of the spindle speed		standard	standard
grinding with conventional corundum grinding wheels		standard	standard
grinding with CBN grinding wheels		option	option

**Internal dressing unit**

designed to operate with stationary dressing tools		standard	standard
designed to operate with driven dressing tools		option	option
spark-in control via acoustics emission (AE) sensors during dressing		option	option

**Automatic re-tooling system**

for grinding tools, measurement sensors etc.		option	option
----------------------------------------------	--	--------	--------

**WOTAN® S3U-F**

(without longitudinal adjustment)

**WOTAN® S3U-L**

(with longitudinal adjustment of the workpiece spindle headstock)

<b>External and surface grinding unit</b>			
<b>Z2 axis (CNC)</b>			
› travel	mm (max.)	1.000	1.000
› resolution	mm	0,0001	0,0001
› minimum adjusting increment	mm	0,001	0,001
› maximum speed	m/min	15	15
<b>X2 axis (CNC)</b>			
› travel	mm (max.)	300	300
› resolution	mm	0,0001	0,0001
› minimum adjusting increment (on the radius)	mm	0,0005	0,0005
› maximum speed	m/min	15	15
stationary external/surface grinding unit (without turret)		standard	standard
› external grinding spindles (stationary)	max. Pcs.	1	1
› dimensions of the external grinding wheel (standard)	mm	Ø500 x 50 x Ø203,2	Ø500 x 50 x Ø203,2
external/surface grinding unit with spindle turret (B3 axis)		option	option
› external grinding spindles (stationary)	max. Pcs.	2	2
› dimensions in the case of 2 grinding wheels being used (standard)	mm	Ø400 x 50 x Ø127	Ø400 x 50 x Ø127
automatic balancing system for external grinding spindles		standard	standard
continuously adjustable setting of the spindle speed		standard	standard
grinding with conventional corundum grinding wheels		standard	standard
grinding with CBN grinding wheels		option	option
<b>External dressing unit</b>			
designed to operate with stationary dressing tools		standard	standard
designed to operate with driven dressing tools		option	option
spark-in control via acoustics emission (AE) sensors during dressing		option	option
<b>Measuring instruments</b>			
measurement sensor for zero point detection		option	option
further measuring equipment		on request	on request
laser measurement of all CNC linear axes (at the WEMA)		yes	yes
<b>Machine control &amp; operation</b>			
SINUMERIK 840 D control SOLUTION LINE from SIEMENS		yes	yes
proprietary operating system WOP Glauchau®		yes	yes
option of remote diagnosis		yes	yes
CNC knowledge required to operate the machine		none	none
<b>Other items</b>			
maintenance contract		on request	on request
spare & wear part package		on request	on request
operator training/flanking production support/etc.		on request	on request



**WOTAN® -I**  
INTERNAL GRINDING



**WOTAN® -U**  
UNIVERSAL GRINDING













**WOTAN® -A**  
EXTERNAL GRINDING



**special solutions**  
CUSTOMIZED PRODUCTS

Our experts will accompany you on the way from the first inquiry to the after-sales service thus ensuring the daily operations of your machine, so that you will get an optimal grinding machine from us.

-  exact agreement of the requirements
-  individual offer for a grinding machine
-  individual design
-  production
-  quality assurance
-  test grinding
-  pre-acceptance of the machine
-  delivery & installation
-  training & familiarization
-  after-sales service

We will be pleased to demonstrate the potential of all our WOTAN® machines at our headquarters in Glauchau, where we also accept grinding jobs for test purposes and on a contract basis.





STATUS: 9/12/2023  
CURRENT INFO  
YOU WILL FIND ON  
OUR WEBSITE.

**NSH TECHNOLOGY GmbH**

Branch Glauchau

 Dieselstrasse 2  
08371 Glauchau · Germany

 +49 3763 61-0

 +49 3763 61-122

 wema-glauchau@nshgroup.com

 WWW.WEMA-GLAUCHAU.COM

**grinding unlimited**  
**MADE IN GERMANY**