

INTERNAL CYLINDRICAL GRINDING MACHINE

for processing very heavy components
or particularly deep internal diameters
with the highest possible degree of precision.



The machine for highly demanding jobs...

Internal cylindrical grinding machines of the WOTAN® S6I series are designed for processing medium-sized and large workpieces. The workpiece spindle can absorb loads of up to 1 200 kg. Our flexible machine design enables us to optimize each machine for your specific grinding jobs.

The **WOTAN® S6I** in its configuration as **WOTAN® S6I-F** is suitable for high-precision cylindrical grinding for processing internal diameters of chuck parts with a **swing diameter** of up to **820 mm** and a **workpiece length** of up to **800 mm** that are **clamped on one side only** without any additional support – particularly suitable for grinding internal front surfaces and internal diameters.

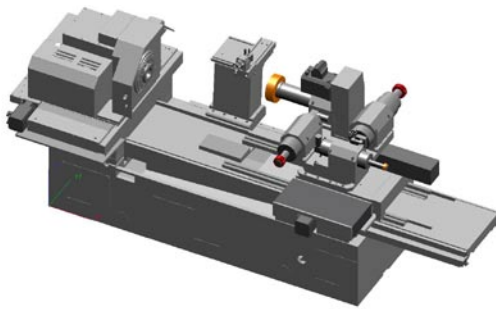

Example of the configuration of a **WOTAN® S6I-F**

As an alternative, the machine can be configured with an **extended work area** as **WOTAN® S6I-L**. This version makes it possible to process shaft-type components with a **length of up to 1 200 or 1 800 mm** and a **diameter of up to 500 mm**, apart from chuck parts clamped on one side only, for which a steady rest needs to be added.

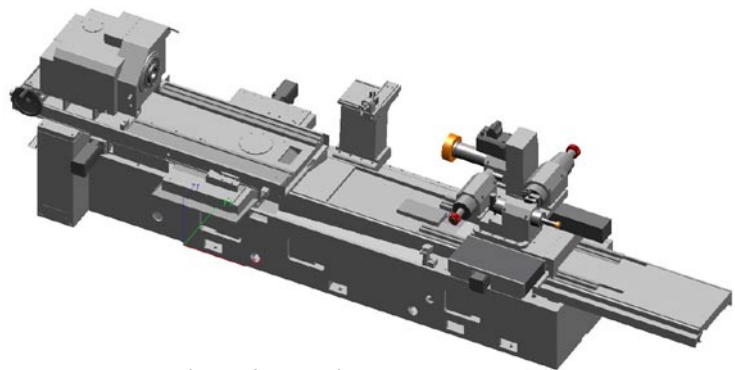

Example of the configuration of a **WOTAN® S6I-L**

...in the field of high-precision internal grinding.

WORKPIECE SPINDLE

On the machining side, the machine is equipped with a swivel axis (**B1 axis**) which can either be **manually operated** (with an angle measuring system) or be **CNC-controlled**. The workpiece spindle headstock will be swiveled with the help of the B1 axis which allows not only a correction of the cylinder but also **taper grinding** in an optimal way.

Moreover, the entire workpiece spindle headstock will be positioned on a transverse axis (**U axis**), so that the machine's **work area** can be extended by positioning the entire workpiece spindle headstock crosswise. Since the U axis is a **positioning axis**, it remains stationary during the grinding process.

LARGE SELECTION OF SPINDLES

Depending on the accuracy requirements, the workpiece spindle can be designed as belt-driven or directly driven spindle or as spindle with a hydrostatic bearing. If the **workpiece spindle is equipped with a measuring system** (C axis), you can perform high-precision **out of round grinding operations** in various applications on a cylindrical grinding machine.

The machine is equipped with a Z axis and an X axis (cross table) on the side of the grinding spindle. The grinding unit on the cross table (X axis is mounted rectangular on the Z axis). This configuration will allow the economical and efficient processing of internal diameters and internal front surfaces **in one clamping**.

Always on the move for you —

FLEXIBLE BY SPINDLE TURRETS

The optional equipment of the machine with a **grinding spindle turret** (B2 axis) with up to **4 grinding spindles** can considerably increase both its flexibility and diversity – without exchanging the spindles. It is either **belt-driven grinding spindles or high-frequency grinding spindles** that are used for this purpose. Belt-driven spindles can be manually exchanged which increases the variability even more.

EXAMPLES OF CONFIGURATIONS FOR THE B2 AXIS

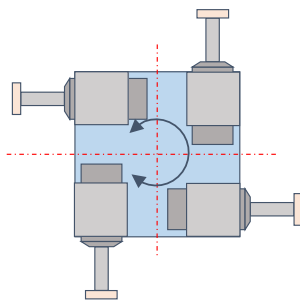

4 high-frequency spindles

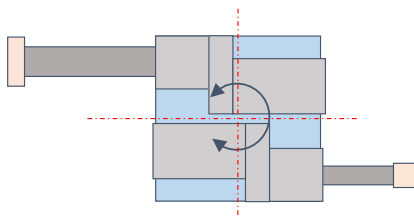

2 belt-driven spindles

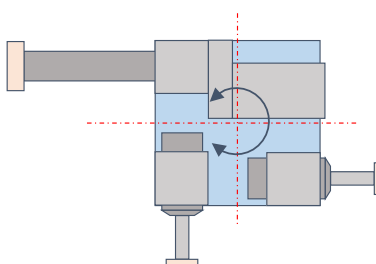

1 belt-driven spindle +
2 high-frequency spindles

EXTERNAL AND SURFACE GRINDING IS ALSO POSSIBLE

The machine will also allow the **additional external and surface grinding** of short seats. In order to do so, a belt-driven grinding spindle equipped with an external and surface grinding wheel (“vector disk”) that is profiled on both sides will be positioned on the grinding spindle turret (B2 axis). A wide range of internal diameters can then be processed with further grinding spindles that are positioned on the grinding spindle turret.

“VECTOR DISKS”

Allows the grinding of internal front surfaces and internal diameters as well as the grinding of external front faces + external diameters

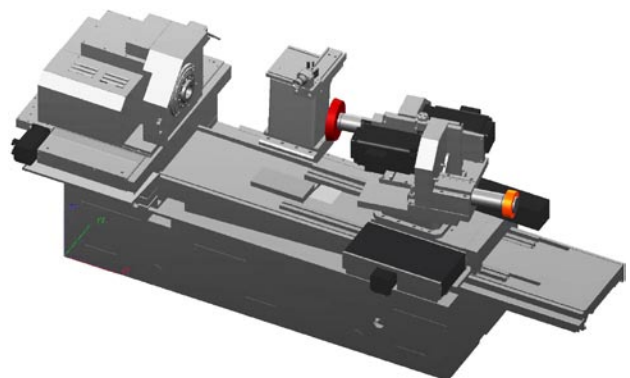
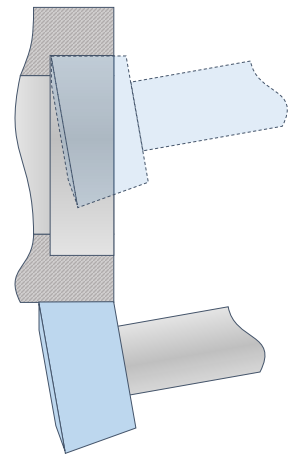

Examples of configurations of the grinding spindle revolver with vector disk and belt-driven spindle

Options for more flexibility.

VARIOUS DRESSERS CAN BE SELECTED

The dressing unit can be equipped with **stationary and driven dressing tools**, which will allow working not only with conventional corundum grinding wheels but also with Cubic Boron Nitride (CBN) grinding wheels.

MODERN CONTROL AND EASY USER INTERFACE

The drive package is based on a **SINUMERIK 840 D** control – SOLUTION LINE – from SIEMENS with the latest generation of servo motors.

All machines are equipped with our own, user-friendly **operator interface with workshop oriented programming (WoP)** that allows an uncomplicated, menu-guided **operation of the machine and its programming without CNC knowledge**. All operations necessary for the process allow the continuous handling of the machine, regardless of its operating status. The standard interface of SIEMENS is also available at the same time.

NUMEROUS OPTIONS AVAILABLE

Depending on the grinding job to be performed, we also integrate a spark-in control & incision detection via a fluid sensor system, more measuring equipment, re-tooling systems and much more.

WOTAN® S6I-L

The **WOTAN® S6I-L** offers an extended work area. The entire workpiece spindle headstock will be placed onto a longitudinal guide (L-adjustment) on the side of the workpiece spindle, so that the headstock can be moved towards the Z-direction, which will also allow using a steady rest on the same longitudinal guide.

WOTAN® S6I at a glance:

	WOTAN® S6I-F (for components clamped on one side only)	WOTAN® S6I-L (for component length of up to approx. 1 200mm 1 800mm)
Work area of the machine		
swing/workpiece diameter in front of the swivel plate	mm (max.) 820	820
swing/workpiece diameter above the swivel plate	mm (max.) –	650
workpiece diameter in the steady rest	mm (max.) –	500
workpiece length clamped on one side only	mm (ca.) 800	800
workpiece length with steady rest	mm (ca.) –	1.200 1.800
grinding diameter during internal grinding	mm (max.) 620	620
grinding depth during internal grinding	mm (max.) 650	1.200
grinding diameter during external/surface grinding	mm (max.) o.r.	o.r.
grinding length during external/surface grinding	mm (max.) o.r.	o.r.
load-bearing capacity at the spindle head (200 mm from the spindle nose)		
› for chuck parts (clamped on one side only)	kg (max.) 650	650
› for shaft-type components (supported by the steady rest)	kg (max.) –	1.300
Workpiece side/workpiece spindle headstock		
workpiece spindle		
› belt-driven	standard	standard
› directly driven	option	option
› with hydrostatic bearing	option	option
swiveling range B1 axis (manual with angle measuring system)	from/to ° +12 / -1	+12 / -1
automatic angle adjustment via B1 axis (CNC)	from/to ° +12 / -1	+12 / -1
C axis for out of round grinding	option	option
U axis (CNC) positioning the entire workpiece spindle headstock crosswise		
› travel	mm (max.) 300	300
› resolution	mm 0,0001	0,0001
› minimum adjusting increment	mm 0,001	0,001
› maximum speed	m/min 15	15
adjustment of the workpiece spindle headstock in Z-direction	mm (max.) –	1.400 2.000
option to use steady rests	no	yes
coolant flow in through the workpiece spindle	option	option
incision detection/spark-in control via the fluid sensor system when grinding	option	option
Automatic re-tooling system		
for grinding tools, measurement sensors etc.	option	option

WOTAN® S6I-F

(for components clamped on one side only)

WOTAN® S6I-L

(for component length of up to approx. 1 200mm | 1 800mm)

Grinding unit			
Z axis (CNC)			
› travel	mm (max.)	800 / 1.100	800 / 1.100 / 1.380
› resolution	mm	0,0001	0,0001
› minimum adjusting increment	mm	0,001	0,001
› maximum speed	m/min	15	15
X axis (CNC)			
› travel	mm (max.)	245	245
› resolution	mm	0,0001	0,0001
› minimum adjusting increment (on the radius)	mm	0,0005	0,0005
› maximum speed	m/min	15	15
grinding spindle turret (B2 axis)		option	option
stationary grinding spindles with/ without grinding spindle turret	max. Pcs.	1 / 4	1 / 4
continuously adjustable setting of the spindle speed		standard	standard
grinding with conventional corundum grinding wheels		standard	standard
grinding with CBN grinding wheels		option	option
Dressing unit			
designed to operate with stationary dressing tools		standard	standard
designed to operate with driven dressing tools		option	option
spark-in control via acoustics emission (AE) sensors during dressing		option	option
Measuring instruments			
measurement sensor for zero point detection		option	option
further measuring equipment		on request	on request
laser measurement of all CNC linear axes (at the WEMA)		yes	yes
Machine control & operation			
SINUMERIK 840 D control SOLUTION LINE from SIEMENS		yes	yes
proprietary operating system WOP Glauchau®		yes	yes
option of remote diagnosis		yes	yes
CNC knowledge required to operate the machine		none	none
Other items			
maintenance contract		on request	on request
spare & wear part package		on request	on request
operator training/flanking production support/etc.		on request	on request



WOTAN® -I
INTERNAL GRINDING



WOTAN® -U
UNIVERSAL GRINDING













WOTAN® -A
EXTERNAL GRINDING



special solutions
CUSTOMIZED PRODUCTS

Our experts will accompany you on the way from the first inquiry to the after-sales service thus ensuring the daily operations of your machine, so that you will get an optimal grinding machine from us.

-  exact agreement of the requirements
-  individual offer for a grinding machine
-  individual design
-  production
-  quality assurance
-  test grinding
-  pre-acceptance of the machine
-  delivery & installation
-  training & familiarization
-  after-sales service

We will be pleased to demonstrate the potential of all our WOTAN® machines at our headquarters in Glauchau, where we also accept grinding jobs for test purposes and on a contract basis.





STATUS: 9/12/2023
CURRENT INFO
YOU WILL FIND ON
OUR WEBSITE.

NSH TECHNOLOGY GmbH
Branch Glauchau

 Dieselstrasse 2
08371 Glauchau · Germany

 +49 3763 61-0

 +49 3763 61-122

 wema-glauchau@nshgroup.com

 WWW.WEMA-GLAUCHAU.COM

grinding unlimited
MADE IN GERMANY